

R51LED

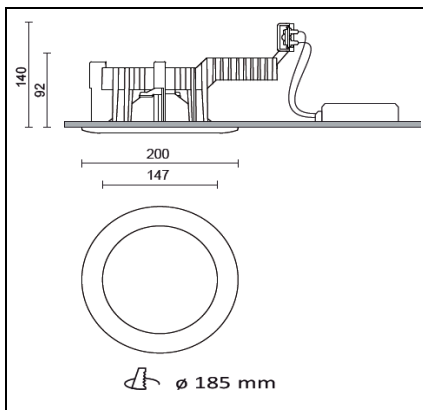

Our Pro Architectural range of LED downlights have been specifically designed for optimum performance and high efficiency.

This robust recessed downlight features a high output LED array light source with impressive heat dissipation, excellent optics and wide light distribution.

Together with their high output and low running costs this range of LED's are fully Part L and ECA compliant.

Materials	Stainless steel body. Polyester painted in white and silver. Other colours available. Tempered sealed 4mm glass cover. Aluminium coated high resistant reflector
Dimensions	W: 200mm x D: 140mm
Weight:	1.8Kg

LED options	4400lm/51w 2700k 4400lm/51w 3000k 4400lm/51w 4000k 4400lm/51w 5000-6000k
-------------	---

IP Rating	IP44
Beam angle	93°
CRI	RA>80
Supply	230/240v 50-60Hz
Heat dissipation	Passive

Part codes	R5127/--/-- 4400LM/51w 2700k
	R5130/--/-- 4400LM/51w 3000k
	R5140/--/-- 4400LM/51w 4000k
	R5150/--/-- 4400LM/51w 5000k
	R5160/--/-- 4400LM/51w 6000k

R51--/HF/--	High Frequency
R51--/D1/--	1-10v dimming
R51--/D2/--	Dsi dimming
R51--/D3/--	Dali dimming

R51--/--/WH	White bezel
R51--/--/SI	Silver bezel
R51--/--/SP	Special RAL finish

PerformanceLED
www.performanceled.co.uk
info@performanceled.co.uk

Technical LED solutions

